

MCB 202 SINGLE MIX BICARB SYSTEM

OPERATION & MAINTENANCE MANUAL

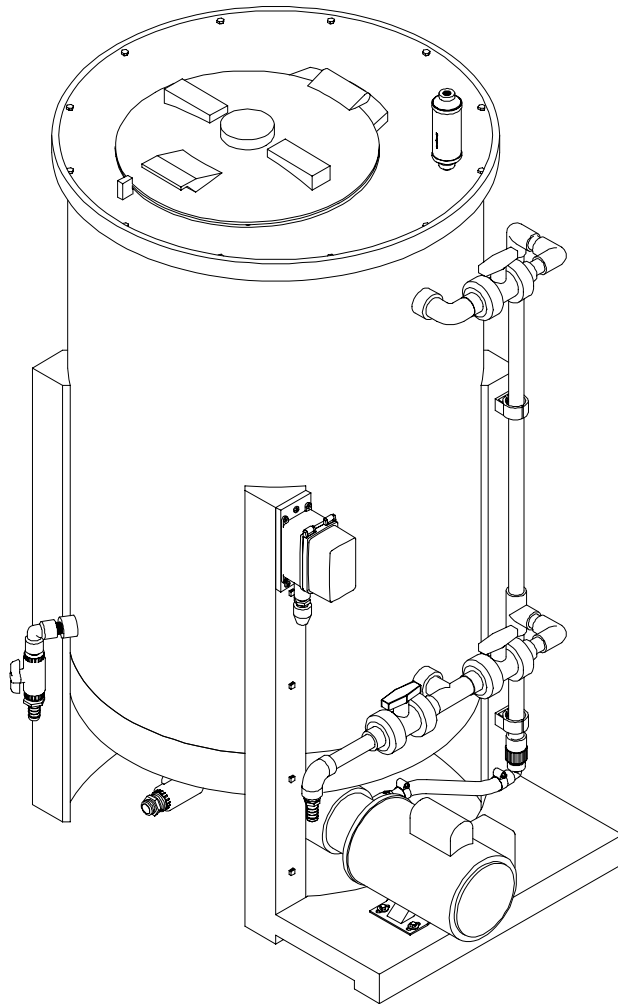

MCB 202 Single Mix Bicarb
Installation, Operation, and Maintenance Manual

TABLE OF CONTENTS

CHAPTER ONE:		GENERAL INFORMATION	1
Section	1.1	General	1-1
	1.2	Safety	1-1
CHAPTER TWO:		SYSTEM INFORMATION	2-1
Section	2.1	Utility Requirements	2-1
	2.2	Dimensions/Operating Space	2-2
	2.3	Installation	2-2
	2.4	Components of the Bicarb System	2-2
	2.5	Service Assistance	2-4
	2.6	Symbols and Abbreviations	2-5
	2.7	Environmental and Storage Consideration	2-5
CHAPTER THREE:		INITIAL SYSTEM START-UP	3-1
Section	3.1	Bicarb System Set-Up	3-1
CHAPTER FOUR:		SYSTEM OPERATION	4-1
Section	4.1	Bicarb Mixing	4-1
CHAPTER FIVE:		SYSTEM CLEANING AND DISINFECTING	5-1
Section	5.1	Introduction	5-1
	5.2	Bicarb System Pre-Rinse	5-1
	5.3	Bicarb System Disinfecting	5-2
	5.4	Bicarb System Rinse	5-4
CHAPTER SIX:		SYSTEM MAINTENANCE	6-1
Section	6.1	Bicarb Components	6-1
	6.2	Schedule	6-2
CHAPTER SEVEN:		SYSTEM TROUBLESHOOTING	7-1
Section	7.1	Mix Pump	7-1
	7.2	Tank Fill	7-1
	7.3	System Flow	7-1
CHAPTER EIGHT:		SPARE PARTS & SUPPLIES	8-1
CHAPTER NINE:		DRAWINGS	9-1

Mar Cor is a registered trademark of Evoqua Water Technologies LLC, in some countries.

©2024 Evoqua Water Technologies LLC. All rights reserved.

CHAPTER ONE: GENERAL INFORMATION

1.1 General

This manual describes the installation and operation of a MCB 202 Single Mix Bicarb System. This Bicarb System designed and manufactured by us is safe, reliable and easy to use. This system will reduce staff time by providing consistent bicarb mixing, and thorough system cleaning and disinfection.





Standard features of the Bicarb System include:

- All Polyethylene tanks and control units for easy cleaning.
- 3/4 hp (100-gallon) or 1/2 hp (50-gallon) Totally Enclosed Fan Cooled (TEFC) motors.
- 50-Gallon or 100-Gallon Systems is available.

Model Number	Part Number	Description
MCB 202-50	W3T579378	Bicarb Mix, 50 Gallon Tank
MCB 202-100	W3T579376	Bicarb Mix, 100 Gallon Tank

1.2 Safety

Throughout this manual, the following safety words and symbols signify important safety issues with regard to installing and maintaining the system. This safety does not contain all of the safety statements in the manual. Other safety statements are included within the manual text by the following denotations and are highlighted in bold print.

	NOTE: Statement that provides further clarification.
	CAUTION: Statement used to identify conditions that could result in equipment or property damage. Failure to observe may result in damage to the system.
	WARNING: Statement used to identify conditions that could result in personal injury or loss of life.
	PROTECTIVE CONDUCTOR TERMINAL: The symbol shows the Protective Conductor Terminal label used in the equipment.

Read This Manual:

This manual needs to be read and understood prior to operating or servicing this device. Use this manual for future reference or training.

Electrical:

- a. To avoid electrical shock, do not open control panel.
- b. Plug should be removed from wall outlet during servicing.
- c. Do not use an extension cord for operation.
- d. Use only with a grounded outlet and ensure that ground is in plug.

Labeling:

Do not remove any system labels. All labels are important and necessary for understanding system operation. The warning label listed below should be adhered to at all times.



Transporting:

When lifting or carry the MCB 202 use at least 2 persons or properly rated lifting equipment. Ensure all proper safety equipment is used when moving this device.

Use:

Do not use the MCB 202 in hazardous atmospheres or with hazardous material for which the equipment is not designed. If the MCB 202 is used in a manner not specified by the manufacturer the protective features of the unit might be impaired.

Electromagnetic Interference

This equipment generates, uses and can radiate frequency energy and, if not installed and used in accordance with these instructions, may cause harmful interference to other devices in the vicinity. However, there is no guarantee that interference will not occur in a particular installation. If this equipment does cause harmful interference with other devices, which can be determined by turning the equipment off and on, the user is encouraged to try to correct the interference by one or more of the following measures:

- Reorient or relocate the receiving device
- Increase the separation between the equipment
- Connect the equipment into an outlet on a circuit different from that to which other device(s) is connected.
- Consult the field service technician or manufacturer for help

Disposal

Disposal of this product or parts must be carried out according to local disposal codes.

CHAPTER TWO: SYSTEM INFORMATION

2.1 Utility Requirements

NOTE: Prior to installing the MCB 202, it is necessary to provide and create an environment suitable for trouble free operation of the system.

2.1.1 Water:

RO or DI water produced to AAMI standards for Hemodialysis. A minimum of 20 PSI is recommended for consistent filling and a maximum of 60 PSI. It must not exceed 30 LPM (8 GPM).

2.1.2 Electrical:

System must be supplied with an 115V, Single Phase, 20 Amp, 60 Hz power supply. An 8 ft. cord with US type plug connector is supplied with every unit. Histories of power failure, power surges, and low line voltages should be noted and reported to the manufacturer or their agent as they may create adverse conditions for the equipment's operation.

Machine Electrical Rating Table				
Part Number	Voltage Rating	Amperage Rating	Phase	HZ
W3T579378	115	7.4	1	60
W3T579376	115	9.7	1	60

2.1.3 Drain

A drain outlet is required for the Bicarb mixer. A floor drain is recommended for proper operation (minimum 1”).

2.1.4 Piping

Plumbing materials can significantly contribute to the contamination of the system. Schedule 40 or 80 PVC pipes, polypropylene, PVDF, and other FDA recommended materials are suitable for the system. Care must also be exercised in the choice of a thread sealant. Teflon tape is suitable for all threaded connections in this system.

WARNING: Ordinary pipe dope must be avoided since it may leach objectionable and potentially dangerous impurities into the water. For thread sealing, use a product that is compatible with pure water applications.

2.2 Dimensions/Operating Space

The following are the system dimensions:

- Width: 3' 6"
- Depth: 3' 0"
- Height: 5' 1" (100 gallon) without vent filter
3' 7" (50 gallon) without vent filter

For easy and safe operation, we recommend that there be a minimum of 2 feet on each side and 4 feet in the front of the system. Due to the wet environment, we recommend that the system be placed in a curbed area with a drain. This area should be at least 5 feet by 5 feet. The floor drain can also be used as the system drain.

NOTE: Do not position the unit so it is difficult to disconnect the power cord from the outlet.

2.2.1 Operating Weight

<u>Part Number</u>	<u>Operating Weight</u>
W3T579378	600 LBS
W3T579376	1020 LBS

2.3 Installation

The bicarb system ships ready to operate. There are two system connections:

- Inlet (feed water): 3/4" schedule 80 PVC
- Drain: 1" schedule 80 PVC

NOTE: For the feed water line, we recommend that a valve be placed prior to the system for emergency system shut-off and that a 3 GPM flow restrictor also be installed to limit the amount of water that can be drawn off of the water system.

NOTE: For cleaning, we recommend a bypass around the flow restrictor to allow the unit to fill faster. This should substantially reduce the clean and disinfection time of the unit.

NOTE: Unions should be installed on all connections to allow the unit to be moved for servicing. Connections may be made with tubing.

2.4 Components of the Bicarb System

The following identifies and describes the function of each valve and test port. All valves are tagged or labeled.

2.4.1 Valve Labels

- V1** - System Fill Valve
- V2** - Mix Valve
- V3** - Jug Port/Sample Valve
- V4** - System Drain Valve
- V5** - Spray Nozzle Valve
- Jug Port** - Jug Port Valve Pressurized Fill

2.4.2 Mix Tank

The tank and stand is constructed of polyethylene. It includes an eductor, which creates a swirling motion in order to properly dissolve the powder into solution. The system comes equipped with a spray nozzle, which is used to conveniently and effectively clean and disinfect the tank. The tank includes a hinge-top lid.

2.4.3 Pump

The system is equipped with a magnetic drive pump and motor which is designed to mix the bicarb powder into solution. It is controlled by the pump power button.

2.4.4 Vent Filter

A vent filter is installed on the tank cover. The cartridge style vent filter inhibits dust and debris from entering the tank.

2.4.4.1 Vent Filter Installation

Remove plug from tank cover vent filter opening. Remove dust plugs from vent filter housing ends. Apply thread tape to nipple. Install nipple into arrow end of vent filter. Install assembled parts into tank cover.

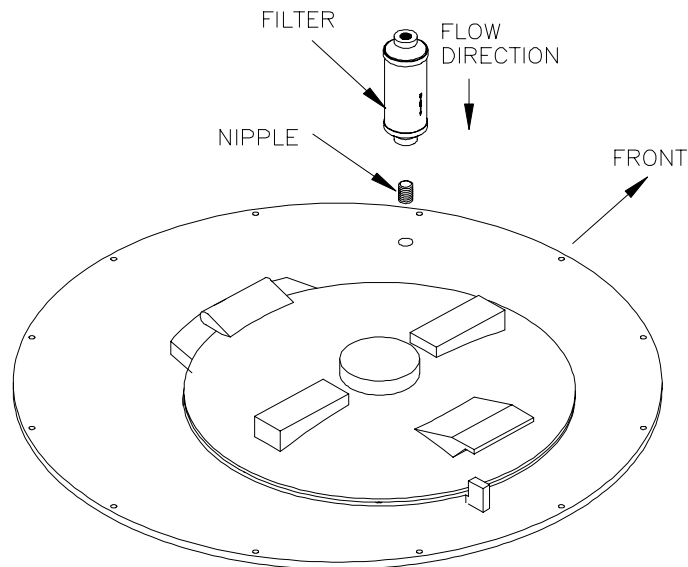

2.4.5 Pump Power Button Panel

Select the amount of time the pump operates: 2 minutes, 5 minutes, 10 minutes, and 15 minutes. The blank button stops the pump. To override a time selection press another time selection.

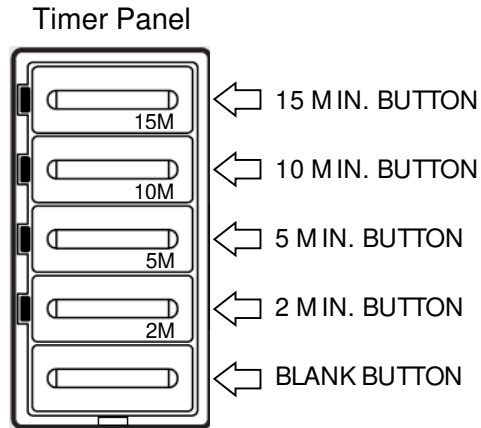

2.5 Service Assistance

If service assistance is required, take the following steps:

1. Consult the “Trouble Shooting” section of this manual (Chapter 5.0). If the problem cannot be identified and corrected by any of the procedures found in that section, then . . .
2. Contact your Facility Equipment Technician. If the technician is unable to help, then . . .
3. Call Technical Support Department at (800) 633-3080. Technicians are available for all calls between 7:00am and 7:00pm CST, Monday through Friday. Technicians are also available at other time for emergency calls only. Technicians will be on hand to discuss the problem with you and endeavor to rectify it over the phone. If the problem appears to be of a more serious nature, you will be given instructions regarding the action to be taken. Prior to making the phone call, you must be prepared to answer two questions.

1. What model do you have? _____

2. What is the serial number? _____

4. In addition, for non-Emergency issues you may email technicalsupport.marcor@xylem and a technician will respond generally within one working day.

2.6 Symbols and Abbreviations

AAMI	Association for the Advancement of Medical Instrumentation
AMP	Ampere
DI	Deionization
ft	Foot (feet)
GPM	Gallons Per Minute
hp	Horse Power
lbs	Pounds
LPM	Liters Per Minute
NPT	National Pipe Thread
PVC	Polyvinyl Chloride
RO	Reverse Osmosis
VAC	Volts Alternating Current

2.7 Environmental and Storage Considerations

- 2.7.1 Operating Temperature Range: 38 to 104°F.
- 2.7.2 Operating Relative Humidity: 45% to 85%, no condensing.
- 2.7.3 Storage Temperature Range: 38 to 104°F.
- 2.7.4 Storage Relative Humidity: 45% to 85% no condensing.

NOTES:

CHAPTER THREE: INITIAL SYSTEM START-UP

3.1 Bicarb System Set-Up

WARNING: The Bicarb System needs to be cleaned and disinfected prior to being ready for patient use.

1. Place Bicarb System into position and attach AAMI quality feed water to the inlet and then make the necessary drain connections.
2. All valves should be in the closed position.
3. Plug the system in per specifications (Refer to Section 2.1).
4. The system should be cleaned and disinfected prior to initial use. Follow System Clean/Disinfect steps under Section 5.0.

NOTES:

CHAPTER FOUR: SYSTEM OPERATION

4.1 Bicarb Mixing



WARNING: If the Cleaning/Disinfecting procedure was used prior to a new batch of bicarb being made, a residual test should be performed prior to the initiation of the mixing cycle (see the rinse procedure in Section 4.2 if necessary).

1. Open **V1** and fill tank to 95 liters (25 gallons). Close **V1**.
2. Open **V2** and ensure **V5** is closed.
3. Turn pump ON for 10 minutes by pressing  button.
4. Adjust mix flow using mix control valve **V2** to minimize vortex if necessary.
5. Slowly add bicarb powder through hinged lid.

CAUTION: If bicarb powder is added too fast, the pump may clog and could result in irreversible damage to the pump.

6. If necessary, open **V1** and fill the tank to the desired batch level.
7. Close **V1** and continue mixing until powder is dissolved.

NOTE: Total mixing time should not exceed 10 minutes.

8. Pump should turn OFF automatically. Press the  button to stop the pump.
9. Close **V2**.
10. Pull sample for testing from **V3**. Upon approval, proceed.
11. Fill jugs manually at Jug Access Port **V3**.
12. To fill jugs using the pump open **V2**, place an empty jug under the jug port valve, press  button and use the Jug Port Valve to fill the jugs.

CAUTION: Operating the Jug Port Valve while the mixer is in the ON mode must be done with care. The contents are pressurized causing the jugs to fill quickly. Do not leave unattended.

13. Once filling is complete, press the  button to stop the pump. Close the Jug Port Valve and **V2**.

CAUTION: To use all of the mixed bicarbonate solution in the tank. Follow step 12. Do not run the pump dry or irreversible damage could occur.

NOTES

CHAPTER FIVE: SYSTEM CLEANING AND DISINFECTING

5.1 Introduction



NOTE: Disinfecting should be done every night after system operation unless proven documented results in accordance with customer's policies and procedures demonstrate otherwise so as to maintain bacteria and endotoxin levels that are in accordance with AAMI standards. It is recommended that the system be disinfected on a weekly basis.

For disinfecting, the recommended total contact time for the bicarb system is one (1) hour. This includes introducing the approved disinfecting agents (1% peracetic acid or household bleach 1% mixture by volume), recirculating the solution through the system, testing for positive presence at each point, dwell time, and rinsing. If less time (for example 30-45 minutes) is practiced and still maintains acceptable culture results than that can be used as an approved maintenance practice. However, if higher culture counts are noted than a change in the practice is required. The organization recommends that the system be rinsed every night following normal system operation.



1. There are 3 basic steps to disinfecting the bicarb system:
 - a. STEP 1: System Pre-Rinse (Section 5.2) – designed to rinse bicarb from the system. This procedure should be done nightly after normal operation.
 - b. STEP 2: System Disinfecting (Section 5.3) – procedures for cleaning/disinfecting the bicarb system.
 - c. STEP 3: System Rinsing (Section 5.4) – procedures for rinsing out the cleaning/disinfecting solution in order to return the system to normal operation.

WARNING: System disinfecting should NOT be done while the bicarb system is in use for patients or possible harm could occur.

5.2 Bicarb System Pre-Rinse

1. After completion of jug filling (either method), drain any solution using valve **V4**.
2. Close valves **V2**, **V3**, **V4**, **V5**, and **Jug Port**.
3. Using valve **V1** add 95 liters (25 gallons) of AAMI quality water, close valve **V1** when completed.
4. Open valve **V2**.
5. Press the  button to rinse the pump. During this 2 minute cycle, place the container under the **Jug Port** valve or run to drain. Open the **Jug Port** valve and rinse for 30 seconds then close the **Jug Port** valve.
6. Once the pump shuts off, close valve **V2** and open valve **V5**. If the pump keeps running after the 2 minutes ends press the  button to stop the pump.

CAUTION: Make sure the tank lid is closed on the top of the tank or the operator might be sprayed.

7. Press the  button to rinse the tank. During this 5 minute cycle, place a container under valve **V3** or run to drain. Open the valve and rinse for 30 seconds then close the valve. If the pump keeps running after the 5 minutes ends press the  button to stop the pump.
8. Repeat above steps 3-7 until residual bicarbonate is absent from the system. Once clear, open valve **V4** to drain the tank, closing it when the tank is completely drained.
9. The bicarb system has now been successfully rinsed.

5.3 Bicarb System Disinfecting



1. Determine the disinfecting batch size that is required up to the tank's maximum level. **Batch Size** is based on the following parameters:
 - a. The disinfecting agent solution strength. See Section 6.0 for specifications on cleaning/disinfecting agents.
 - b. Enough water for the tank. Minimum recommended is 95 liters (25 gallons).
2. Drain the liquid left in the tank by opening valve **V4**. After the tank is completely drained then close valves **V2, V3, V4, V5, and Jug Port**.
3. Using valve **V1** add the necessary amount of AAMI quality water, close valve **V1**, when completed.
4. Open valve **V2**.
5. Press the  button to circulate the water to begin disinfecting the pump.
6. Add the disinfectant solution slowly through the top of the bicarb mix tank.

WARNING: Wear gloves, eye protection, and all PPE as required.

WARNING: Place a label or sign on the bicarb system stating "WARNING DO NOT USE".

7. Test the solution per the manufacturer's recommendation through valve **V3** allowing it to run for 30 seconds into a container, then close valve **V3**.
8. Place a container under the **Jug Port** valve or run to drain. Open the **Jug Port** valve and flush for 30 seconds, then close the **Jug Port** valve.
9. After the pump shuts off, open valve **V5** and close valve **V2**. If the pump keeps running after the 2 minutes ends press the  button to stop the pump.

CAUTION: Make sure the tank lid is closed on the top of the tank or the operator might be sprayed.



10. Press the  button to begin disinfecting the tank. If the pump keeps running after the 5 minutes ends press the  button to stop the pump.

NOTE: Allow the entire system to dwell for 1 hour. Recirculate every 15 minutes for 5 minutes. When disinfecting, the recommended total contact time is 1 hour. Contact time begins at the time the disinfectant solution was introduced into the system.



11. After the necessary contact time has expired, close valve **V5**, then drain all the solution from the tank using valve **V4**, closing it when the tank is completely drained.
12. To rinse the system, follow the steps in Section 5.4.

5.4 Bicarb System Rinse

WARNING: Keep all warning labels or signs in place until final rinse steps are completed. Use the appropriate residual test to verify absence of cleaner/disinfectant. Wear all necessary PPE.

1. Drain any liquid left in the tank by opening valve **V4**, after the tank is completely drained close valves **V2**, **V3**, **V4**, **V5**, and the **Jug Port** valve. Using valve **V1**, add 95 liters (25 gallons) of AAMI quality water, close valve **V1** when completed.
2. Open valve **V2**.
3. Press the  button to rinse the pump. During this 2 minute cycle, place a container under the **Jug Port** valve or run to drain. Open the **Jug Port** valve and rinse for 30 seconds then close the **Jug Port** valve.
4. Once the pump shuts off, close valve **V2** and open valve **V5**. If the pump keeps running after the 2 minutes ends press the  button to stop the pump.

CAUTION: Make sure the tank lid is closed on the top of the tank or the operator might be sprayed.

5. Press the  button to rinse. During this 5 minute cycle, place a container under **V3** or run to drain. Open the valve **V3** and rinse for 30 seconds then close valve **V3**.
6. Repeat Steps 1-5 until residual cleaner/disinfectant is absent from the system. Once clear, open valve **V4** to drain the tank, closing it when the tank is completely drained. If the pump keeps running after the 5 minutes ends press the  button to stop the pump.
7. Record date, time, and the operator's initials in a log sheet.
8. The system has now been cleaned/disinfected and rinsed thoroughly. Remove all warning labels or signs. The system is now ready for normal operation.

WARNING: Due to the possibility of disinfectant rebound, a residual test should be performed prior to the initiation of the mixing cycle for bicarbonate.

NOTES:

CHAPTER SIX: SYSTEM MAINTENANCE

6.1 Bicarb Components

1. Pump - The pump is a 3/4 hp (100 gallon) or 1/2 hp (50 gallon) TEFC motor that requires no maintenance.

CAUTION: The mix pump must be kept clean to assure long life with minimal interruptions. We recommend the use of vinegar in the pump on a quarterly basis to keep bicarb from calcifying in the pump head.

2. Inspect the unit's hoses, fittings and PVC pipes every week for leaks or damage. Replace as needed. The spare part numbers for the hoses and fittings can be found in Section 8 of this manual. Contact Technical Service Department for assistance.
3. System Disinfecting – Disinfection should be done with agents that meet the following criteria:
 - a. Peracetic Acid – Per manufacture's specifications (1% Minncare is standard and recommended).
 - b. Bleach, Household – 1% mixture (By Volume).

Chemical Mix Table						
Disinfectant	QTY	%		Decalcifier	QTY	%
Bleach (Household)	0.95 Liters or 32 ounces	1%		Acetic Acid	4.73 Liters or 1.25 Gallons	5%
Peracetic Acid (Minncare HD®)	0.95 Liters or 32 ounces	1%		Citric Acid	4.73 Liters or 1.25 Gallons	5%

NOTE: Add quantities listed to 95 liters (25 gallons) of water.

WARNING: Do Not Mix Chemical Together.

WARNING: Follow all applicable Safety Data Sheet (SDS) precautions and OSHA Standards when handling any chemical. Use the appropriate Personal Protective Equipment when handling any chemical. Follow all local, state, and federal regulations when disposing of any chemical.

4. Check the bicarb vent filter monthly for the presence of moisture. Remove the filter shake it with a downward motion, expelling any water. Replace the vent filter if any water is expelled.
5. Check the bicarb tank lid monthly for cracks or degradation, replace if necessary.

Minncare HD® is a registered trademark of Medivators

6.2 Schedule

1. Daily Maintenance. The Bicarb System should be cleaned every evening after the final patient shift. See Section 5.1.
2. Weekly Maintenance. The Bicarb system should be rinsed and disinfected after the final patient shift. See Section 5.1. The unit must then be rinsed of the disinfectant and have a negative result. Inspect the system for leaks or damage Repair as necessary.
3. Monthly Maintenance. Bacterial monitoring should be preformed on a monthly basis once the initial cultures have been preformed on the system. After disinfection and rinse, the bacteria samples should be retaken and tested accordingly. Follow clinics procedures as required.
4. Quarterly Maintenance. The Bicarb System should be decalcified. Acetic acid (e.g. vinegar) or citric acid is an acceptable solution. This may need to be performed more often depending upon precipitation formation.
5. Yearly Maintenance. Replace the vent filter.

CHAPTER SEVEN: TROUBLESHOOTING

7.1 Mix Pump

1. Pump Noisy
 - a. Verify fluid availability.
 - b. Ensure proper ball valve orientation. Pump will not function properly without fluid.
 - c. Clean the pump to remove any bicarbonate build-up.
 - d. Inspect the pump for damage.
 - e. Replace the pump.
2. Pump Does Not Run
 - a. Verify fluid availability.
 - b. Make sure the unit is plugged in and with power to the outlet.
 - c. Faulty motor, replace the pump.
3. Pump Continues Running
 - a. Check the pump control switch function.
 - b. Unplug the MCB202 from the electrical power source.

7.2 Tank Fill

1. No Water
 - a. Check to make sure purified water is turned on or opened to the unit.
 - b. Replace the valve.

7.3 System Flow

1. No bicarb flow from Jug fill/Sample valve.
 - a. The V3 jug fill works with gravity feed. A minimum of 38 liters (10 gallons) needs to be in the tank to use V3.
 - b. Use the Jug Port valve to fill a jug using pump pressure. Be sure V2 is OPEN and the pump is operating.

NOTES

CHAPTER EIGHT: SPARE PARTS & SUPPLIES

Supplies and replacement parts are available by calling 1-800-752-1402. Replacement parts can be ordered by referring to the system diagram. The following supplies are available and can be shipped immediately:

Spare Parts List:

Description	Part Number
Minnicare 400 Cold Sterilant, 4 x 1 quart, case	W2T912423
Minnicare 1% test strips	W2T912435
Minnicare residual test strips	W2T912432
¾ hp Mix pump (100 gallon)	W2T912393
½ hp Mix pump (50 gallon)	W2T912391
Pump Wet End Kit (100 gallon)	W2T912394
Pump Wet End Kit (50 gallon)	W2T912212
¾" Compact Ball Valve, PVC	W2T913024
1" Compact Ball Valve, PVC	W2T913025
¾" T/U Ball Valve, PVC	W2T369988
¾" MNPT x ¾" MGHT Dixon	W2T912782
¾" MNPT x ½" HB 90 Dixon	W2T378189
Flow control nipple, PVC, 3 gpm	W2T913450
Filter, 5 Micron, tank cover	W2T913128
O-ring, 16" Dia. EPDM	W2T914554

CHAPTER NINE: DRAWINGS

MCB 202 - Single Mix Bicarb

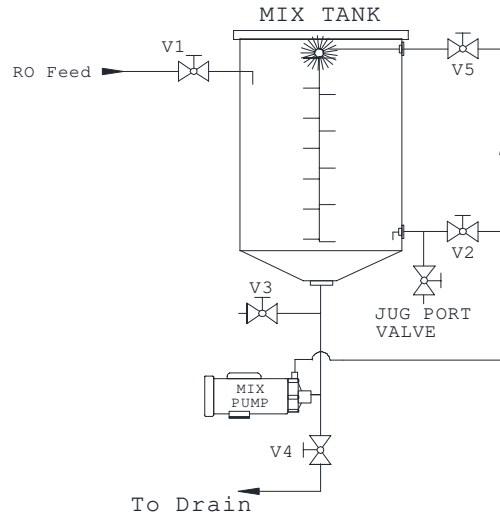

Fill Mode

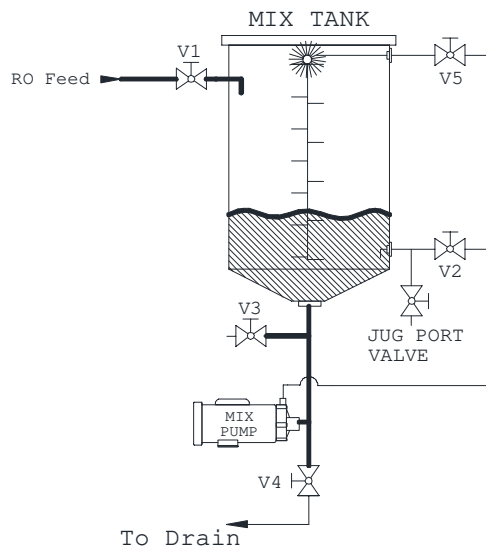

Mix Mode

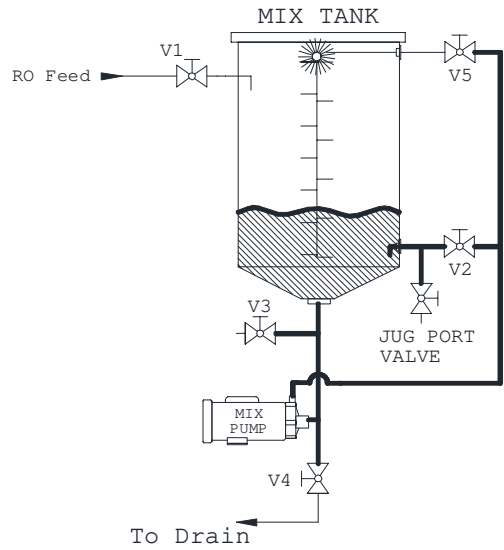

Clean & Disinfect Mode

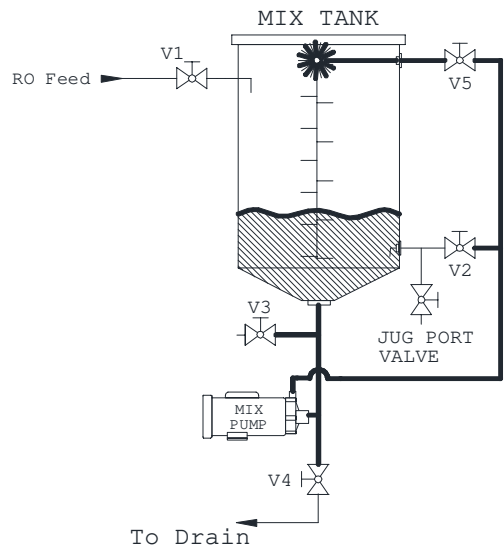

BICARB DISTRIBUTION THROUGH JUG PORT VALVE

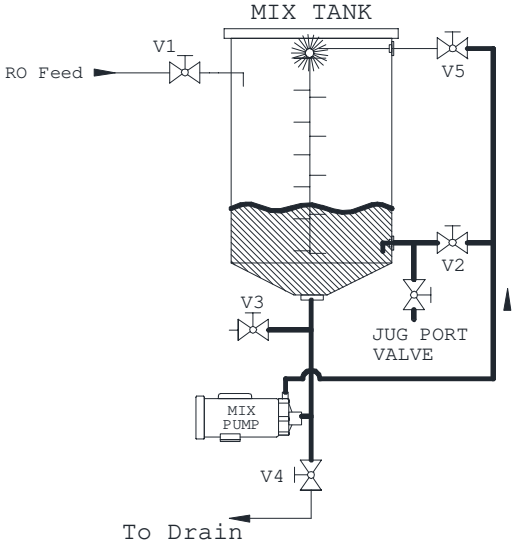

NOTES:

This page intentionally left blank.

Call (800) 633-3080 for additional information or visit www.mcpur.com.



14550 28th Ave N,
Plymouth, MN 55447
Ph: 800-633-3080
Fax: 763-210-3868